

ALL BLACK INSTALLATION PROCESS AUTO GLASS REPLACEMENT INSTALLATION GUIDELINE

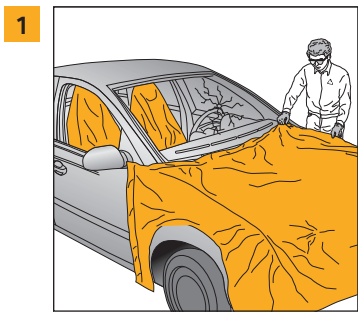

- Wear personal protective equipment
- Cover parts to be protected
- Use seat covers

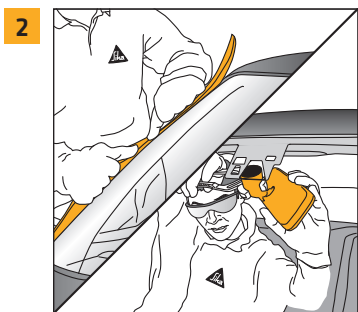

- Carefully remove all trims and accessories
- Carefully remove ADAS related sensors and cameras

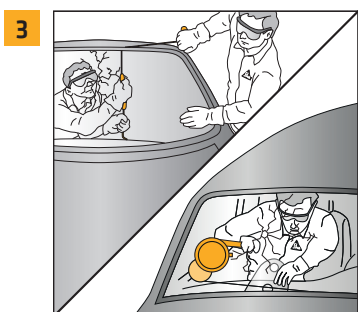

- Cut out damaged windshield using Sika® SmartCut, electrical knife, cutting wire, cold knife etc.
- Remove dirt with a vacuum cleaner or brush

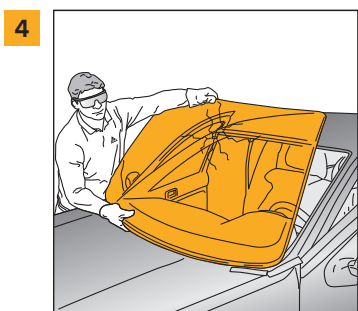

- Remove the damaged windshield

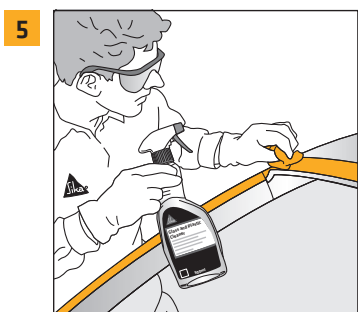

- Remove debris with a vacuum cleaner or brush
- Clean the entire aperture with Sika® Cleaner G+P, making sure the surface is completely dry and no moisture remains

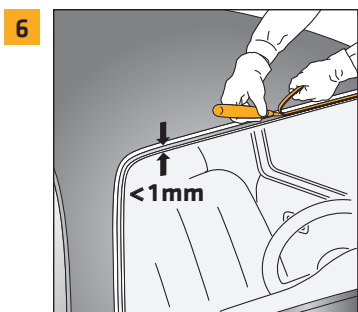

- Trim back the remaining PUR bead and try to cause as little damage as possible
- The remaining PUR must be under 1 mm before it is safe to apply fresh adhesive

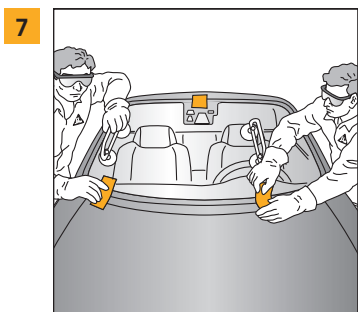

- Dry fit the windshield
- To ensure a quick and precise installation of the windshield once the adhesive is applied, add fitting marks



- Clean the windshield with Sika® Cleaner G+P and check for contamination
- If contaminated, scrub the bonding surface with Sika® Cleaner PCA
- Wipe the window dry with a paper towel

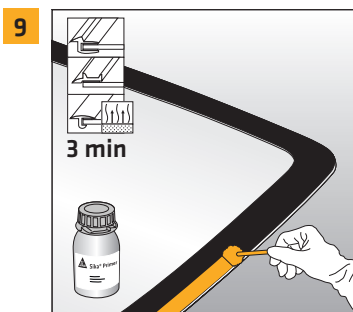

- Use a dauber or Sika® Cleaner PCA stick as applicator
- Prime the bonding surface of the glass using Sika® Primer-207 or Sika® Primer-507
- Tightly close the can immediately after use
- Allow to flash-off for at least 3 minutes



- Cover any minor damage to paint work using Sika® Primer-207 or Sika® Primer-507
- Tightly close the can immediately after use
- Allow to flash-off for at least 3 minutes
- In case of larger areas, contact a paint shop or refer to the car manufacturer's specification

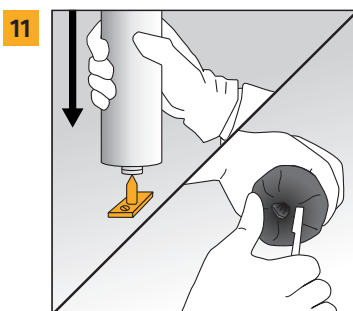

- Cartridge: open by piercing the membrane
- Unipack: open by simply slicing the end of the unipack approx. 1 cm between the clip and the shoulder. Avoid the foil weld
- PowerCure: charge the Dispenser, no need to open manually

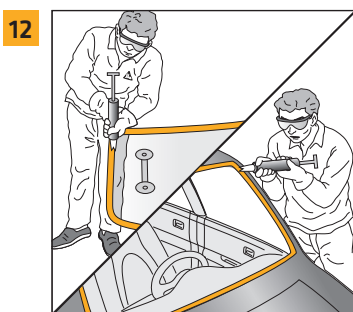

- Prepare a "V" notched nozzle that has the same height as the pinchweld mounting surface and the roof of the car
- Apply a triangular bead of adhesive either to the glass or the aperture
- It is important that the adhesive matches both the primed surface on the glass and the fresh cut bead of urethane

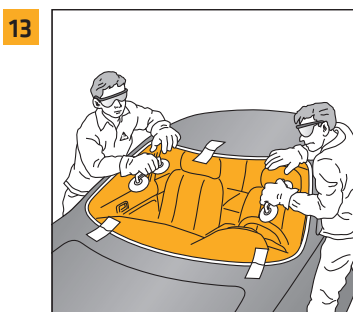

- Place the windshield in position within the open time of the adhesive
- Caution:** the open time may be significantly shorter at elevated temperature

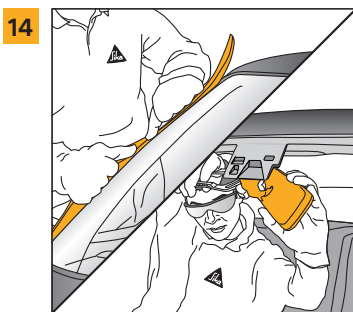

- Remount trim and moldings so that they fit properly, secure all cowlings under the bonnet and affix wipers
- Ensure that all dismantled parts are installed correctly
- Refit and rear-view mirror and check if all ADAS related sensors and cameras work correctly

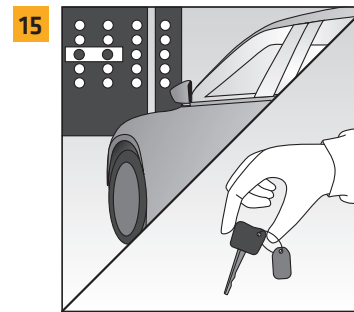

- Conduct and record ADAS recalibration according OEM specification
- Record all batch numbers on job card to insure full traceability
- Complete paperwork and hand back keys to customer after the minimum safe drive-away time is achieved



BONDING SURFACE

Float Glass and Ceramic coated Glass^a

Bare Metal Scratch < 5 cm²

Bare Metal Scratch < 150 cm²

Intact OEM Paint

Repair Paint (after complete curing of paint)^b

PVC/RIM Encapsulation, Pre-applied Adhesive System^b

Fresh Cut Bead

Pre-applied OEM Primer

PC / PMMA glass^c

● = Sika® Primer-207 or Sika® Primer-507

SURFACE PREPARATION STEPS

●

●

●●

●

●

●

●

●

●

●

●

●

●

- a) Windshield must be clean of dirt and dust. Potential contamination must be removed by wet scrubbing with Sika® Cleaner PCA
- b) Scuff surface
- c) Anti Scratch Coating must be removed prior to use, scuff surface. (only for temporary glazing, UV-protection required)

Our most current General Sales Conditions shall apply. Please consult the most current local Product Data Sheets prior to any use.